



ROD SYSTEM

design Piero Lissoni

Supporting structure in lacquered drawn tubular steel, seat sprung with coated rubber elastic straps and padding in polyurethane foam. Backrest and armrest structure in layered HPL panel. Covering in 100% polyether, thermally bonded onto a polyamide velveteen backing. Backrest and seat cushions, joined together by zipper, in prewashed and sterilized goose down stitched into separate compartments, with differentiated density polyurethane foam insert. The seat cushions are quilted with buttons at sight. On request, seat cushions available quilted without buttons. Armrest cushions in polyurethane foam covered with prewashed

and sterilized goose down stitched into separate compartments, with a poplar plywood supporting panel, fixed to the frame by plug-in hinges. Stainless Steel feet, polished or matt satin-finish or lacquered with epoxy powder coating burnished colour or gunmetal grey colour, screwed to the base with a bushing and with adjustable black PVC tips. Fabric or leather upholstery, both fully removable by zippers and Velcro fastenings. Seat depth: 60cm. Table to be used in composition with MDF structure, veneered with Stone Oak® plates, with acrylic paint finish.

Feet

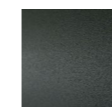

Steel with
Gunmetal Grey
Coating

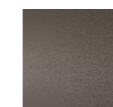

Burnished
Painted Steel



Stainless Steel
with Polished
Finish



Stainless Steel
with Matt
Satin Finish

Table Top

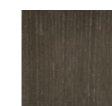

Stone Oak®

Buttons



col. Light

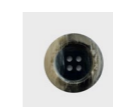

col. Dark



Notes

Standard feet in tubular Stainless Steel Ø1,5cm; on request available in Ø2,2cm.

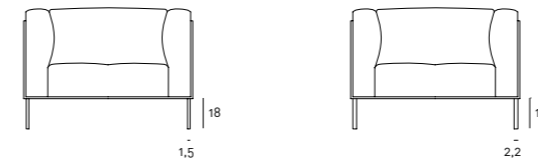

Standard feet Ø1,5cm

On request, available in Ø2,2cm

Buttons available in two variants and, as standard, matching the color of the chosen cover. On request, to be specified when ordering, available also contrasting buttons.

Stone Oak®: this wood owes its particular coloring to an entirely natural process. Because of this, some slabs may look more brown than others. Our commitment is to provide you a high quality product; any differences in color should not be considered as defects.

On request an additional protective (acrylic solvent) painting is available for the Stone Oak® finishing of the table. It should be noted that this additional coating slightly changes the natural color and texture of the surface. Although this supplementary painting increases the surface resistance, it is still a natural material; therefore small superficial stains, due to oil or other substances, have to be promptly removed, before being absorbed in depth by the wood. Thus, we recommend regular care and maintenance.

Modular elements are joined with provided hooks for assembly, as per instruction included in the product. For composition with table and different elements, please attach a sketch to the order. As standard, table provided "suspended" within the elements; kindly specify at time of order if requested with self-supporting feet, and attach the specific drawing of the composition requested to the order.

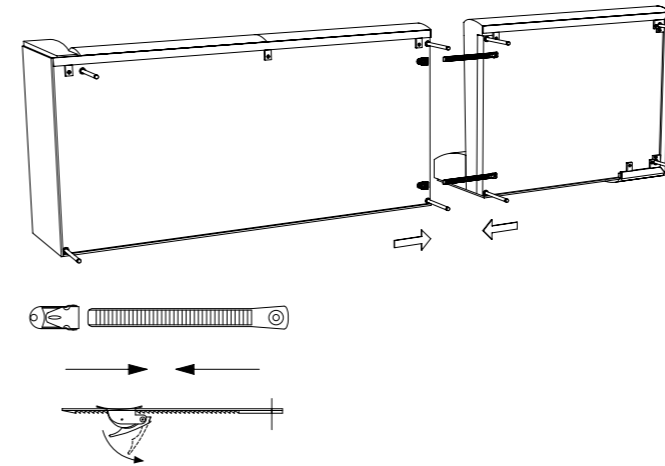

Compositions must always have terminal element with armrest. For compositions with terminal element without armrest, please ask for availability and price.

For composition with different elements, please attach a general sketch to the order.

The composition can be combined with the elements of the model Rod Bean.

Standard seat cushion Rod Bean when in composition with Rod System elements.

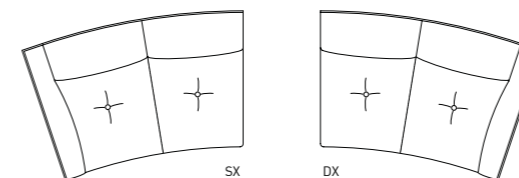

Technical Drawings
Terminal Element

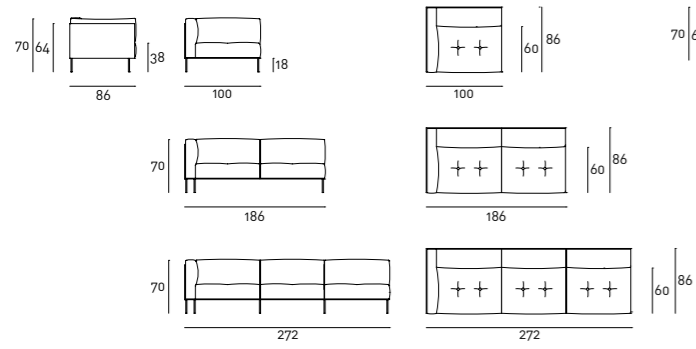

Central Element

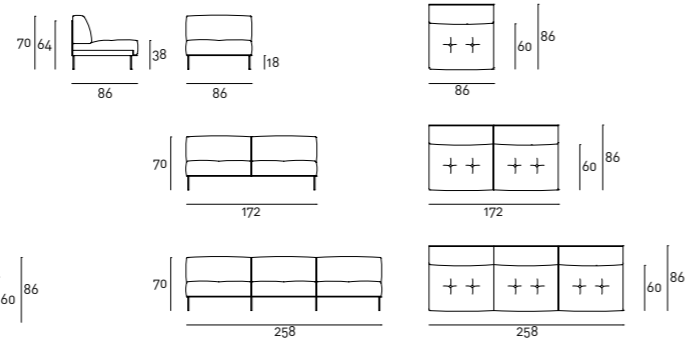

Corner Element

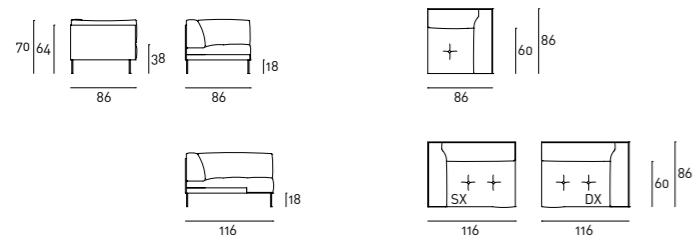

Element with backrest

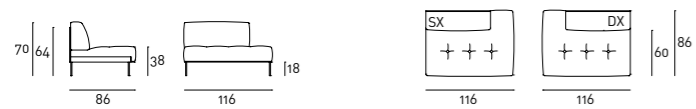

Long Seat

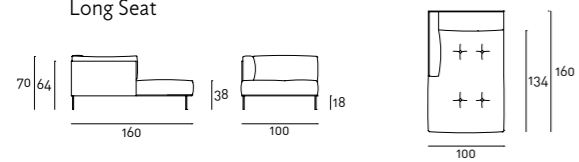

Footrest

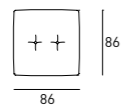
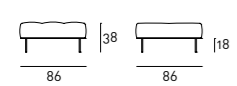
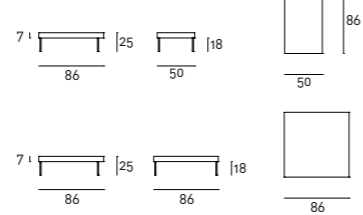

Table for composition



Loose Cushion



Examples of Composition
Composition 01

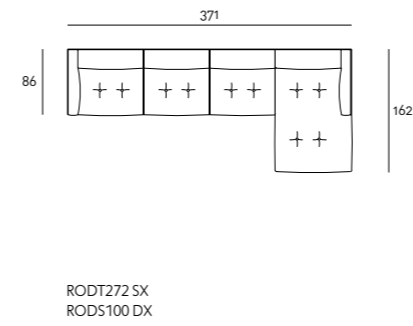

Composition 02

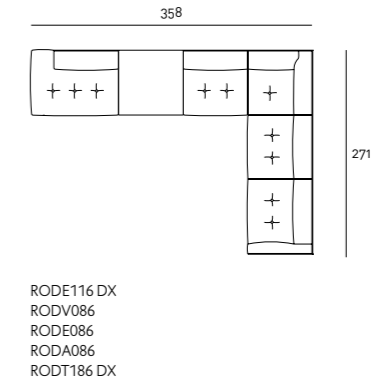

Composition 03

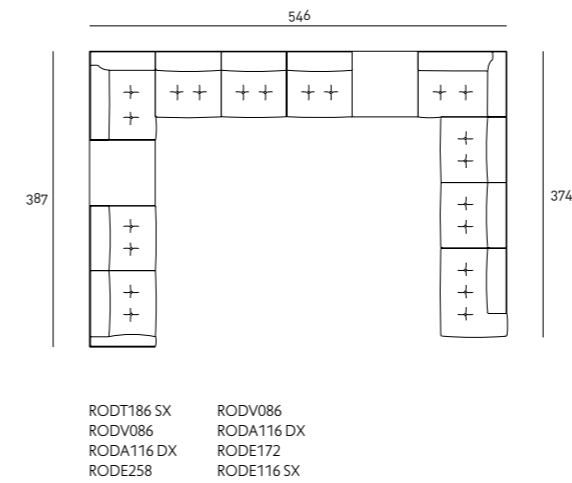

Rod System + Rod Bean/Composition 01

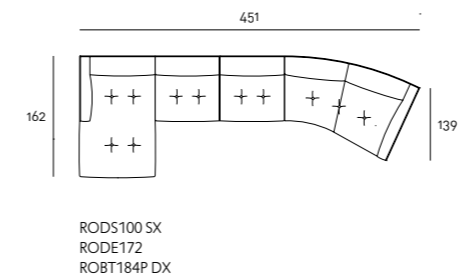

Rod System + Rod Bean/Composition 02

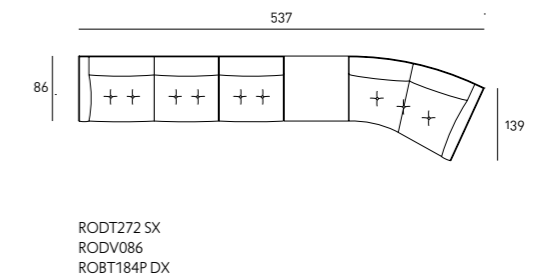

The commercial codes refer to the elements chosen in the above-proposed compositions.

