

Index

String Pocket

String Pocket	3	String Pocket metal	3
---------------	---	---------------------	---

String System

Bottle tray	19	Magazine holder	21
Bowl shelf	13	Magazine shelf wire	12
Bowl shelf felt	13	Magazine shelf wood	12
Cabinet with Mirror Doors	14	Metal Shelf with High Edge	10
Cabinet with Sliding Doors	15	Metal Shelf with Low Edge	9
Chest with Drawers	17	Organizers	21
Coat hanger	20	Plex Panels	6
Display Cabinet	16	Pull Out Drawer	22
Filing cabinet	17	Rods for metal shelves	18
Floor Panels	6	S hook	21
Folding Table	14	Shelves	8
Hanger rack	19	Shoe Shelf Metal	11
Hooks for metal shelves	20	Wall Panels	4
Knife holder	18	Work Desk	11

Museum

Museum shelf	23		
--------------	----	--	--

Works

Bowl for freestanding	27	Freestanding	27
Computer Holder	26	Height adjustable table frame	24
Conference Table Top	25	Mobile storage unit	27
Desktop	25	Table Frame extension	24
Fabric sleeve for wire screen	26	Wire screen for desktop	26

Miscellaneous









Order, freight and claim	28	Terms and conditions	29
--------------------------	----	----------------------	----

String Pocket

String Pocket

String Pocket is a complete shelving package with two panels and three shelves. You can choose among a range of colours and materials. String Pocket can be combined in a host of ways. With one packet you get one shelf, with two packets you can build up to three sections.



#	Article number	Color	Pack	Width/Height/Depth	Note	Price
1	SP5015-12-12	 White/White	1	60/50/15		£105
2	SP5015-14-14	 Beige/Beige	1	-	New 2020	£105
3	SP5015-61-61	 Grey/Grey	1	-		£105
4	SP5015-43-43	 Mustard/Mustard	1	-		£105
5	SP5015-39-39	 Blush/Blush	1	-		£105
6	SP5015-03-13	 Black stained ash/Black	1	-		£105
7	SP5015-05-12	 Oak/White	1	-		£105
8	SP5015-06-12	 Ash/White	1	-		£105
9	SP5015-04-13	 Walnut/Black	1	-		£105

String Pocket metal

String Pocket is a complete shelving package with two panels and three shelves. You can choose among a range of colours and materials. String Pocket can be combined in a host of ways. With one packet you get one shelf, with two packets you can build up to three sections.



#	Article number	Color	Pack	Width/Height/Depth	Note	Price
1	SPM5015-12-12	 White/White	1	60/50/15	New 2020	£125
2	SPM5015-45-45	 Taupe/Taupe	1	-	New 2020	£125
3	SPM5015-46-46	 Neon/Neon	1	-	New 2020	£125

String System

Wall Panels

The threads of the Wall Panels gives String® its true character, and when more space is needed, add panels and shelves. String® Wall Panels comes in two heights, 50 and 75 cm, and two depths, 20 and 30 cm.



#	Article number	Color	Pack	Height/Depth	Note	Price
1	SW5020-12-1	White	1	50/20		£38
2	SW5020-12-2	White	2	-		£60
3	SW5020-14-1	Beige	1	-	New 2020	£38
4	SW5020-14-2	Beige	2	-	New 2020	£60
5	SW5020-61-1	Grey	1	-		£38
6	SW5020-61-2	Grey	2	-		£60
7	SW5020-13-1	Black	1	-		£38
8	SW5020-13-2	Black	2	-		£60
9	SW5020-11-1	Galvanized	1	-		£42
10	SW5020-11-2	Galvanized	2	-		£65
11	SW5020-21-1	Brown	1	-	New 2020	£38
12	SW5020-21-2	Brown	2	-	New 2020	£60
13	SW5030-12-1	White	1	50/30		£42
14	SW5030-12-2	White	2	-		£63
15	SW5030-14-1	Beige	1	-		£42
16	SW5030-14-2	Beige	2	-		£63
17	SW5030-61-1	Grey	1	-		£42
18	SW5030-61-2	Grey	2	-		£63
19	SW5030-13-1	Black	1	-		£42
20	SW5030-13-2	Black	2	-		£63
21	SW5030-11-1	Galvanized	1	-		£46
22	SW5030-11-2	Galvanized	2	-		£69
23	SW5030-21-1	Brown	1	-	New 2020	£42
24	SW5030-21-2	Brown	2	-	New 2020	£63
25	SW7520-12-1	White	1	75/20		£43
26	SW7520-12-2	White	2	-		£67
27	SW7520-14-1	Beige	1	-	New 2020	£43

Wall Panels

The threads of the Wall Panels gives String® its true character, and when more space is needed, add panels and shelves. String® Wall Panels comes in two heights, 50 and 75 cm, and two depths, 20 and 30 cm.



#	Article number	Color	Pack	Height/Depth	Note	Price
28	SW7520-14-2	■ Beige	2	-	New 2020	£67
29	SW7520-61-1	■ Grey	1	-		£43
30	SW7520-61-2	■ Grey	2	-		£67
31	SW7520-13-1	■ Black	1	-		£43
32	SW7520-13-2	■ Black	2	-		£67
33	SW7520-21-1	■ Brown	1	-	New 2020	£43
34	SW7520-21-2	■ Brown	2	-	New 2020	£67
35	SW7530-12-1	□ White	1	75/30		£45
36	SW7530-12-2	□ White	2	-		£70
37	SW7530-14-1	■ Beige	1	-		£45
38	SW7530-14-2	■ Beige	2	-		£70
39	SW7530-61-1	■ Grey	1	-		£45
40	SW7530-61-2	■ Grey	2	-		£70
41	SW7530-13-1	■ Black	1	-		£45
42	SW7530-13-2	■ Black	2	-		£70
43	SW7530-21-1	■ Brown	1	-	New 2020	£45
44	SW7530-21-2	■ Brown	2	-	New 2020	£70

Floor Panels

The threads of the floor panels gives String® its true character. When more space is needed, add panels and shelves. String® floor panels comes in three heights, 85, 115 and 200 cm, and one depth, 30 cm.



#	Article number	Color	Pack	Height/Depth	Note	Price
1	SF8530-12-1	White	1	85/30		£65
2	SF8530-12-2	White	2	-		£108
3	SF8530-14-1	Beige	1	-		£65
4	SF8530-14-2	Beige	2	-		£108
5	SF8530-61-1	Grey	1	-		£65
6	SF8530-61-2	Grey	2	-		£108
7	SF8530-13-1	Black	1	-		£65
8	SF8530-13-2	Black	2	-		£108
9	SF8530-11-1	Galvanized	1	-		£69
10	SF8530-11-2	Galvanized	2	-		£115
11	SF8530-21-1	Brown	1	-	New 2020	£65
12	SF8530-21-2	Brown	2	-	New 2020	£108
13	SF11530-12-1	White	1	115/30		£76
14	SF11530-12-2	White	2	-		£131
15	SF11530-14-1	Beige	1	-		£76
16	SF11530-14-2	Beige	2	-		£131
17	SF11530-61-1	Grey	1	-		£76
18	SF11530-61-2	Grey	2	-		£131
19	SF11530-13-1	Black	1	-		£76
20	SF11530-13-2	Black	2	-		£131
21	SF11530-21-1	Brown	1	-	New 2020	£76
22	SF11530-21-2	Brown	2	-	New 2020	£131
23	SF20030-12-1	White	1	200/30		£97
24	SF20030-12-2	White	2	-		£179
25	SF20030-14-1	Beige	1	-		£97
26	SF20030-14-2	Beige	2	-		£180
27	SF20030-61-1	Grey	1	-		£97
28	SF20030-61-2	Grey	2	-		£179
29	SF20030-13-1	Black	1	-		£97

Floor Panels

The threads of the floor panels gives String® its true character. When more space is needed, add panels and shelves. String® floor panels comes in three heights, 85, 115 and 200 cm, and one depth, 30 cm.



#	Article number	Color	Pack	Height/Depth	Note	Price
30	SF20030-13-2	■ Black	2	-		£179
31	SF20030-21-1	■ Brown	1	-	New 2020	£97
32	SF20030-21-2	■ Brown	2	-	New 2020	£180

Plex Panels

String® Plex, developed in 1954, has panels of laser cut clear perspex. This has the effect of making the shelves seem to hover, giving the whole shelving unit an extra light appearance. String® Plex is available in two heights, 50 and 75 cm, and two depths, 20 cm and 30 cm.



#	Article number	Color	Pack	Height/Depth	Note	Price
1	SPW5020-20-1	□ Clear perspex	1	50/20		£51
2	SPW5020-20-2	□ Clear perspex	2	-		£81
3	SPW5030-20-1	□ Clear perspex	1	50/30		£53
4	SPW5030-20-2	□ Clear perspex	2	-		£84
5	SPW7520-20-1	□ Clear perspex	1	75/20		£57
6	SPW7520-20-2	□ Clear perspex	2	-		£88
7	SPW7530-20-1	□ Clear perspex	1	75/30		£63
8	SPW7530-20-2	□ Clear perspex	2	-		£97

Shelves

The Shelves are easy to move around. When additional space is needed, you can add more shelves and panels. Shelves comes in two widths, 58 and 78 cm, and two depths, 20 and 30 cm.



#	Article number	Color	Pack	Width/Height/Depth	Note	Price
1	5820-12-3	White	3	58/2/20		£70
2	5820-14-3	Beige	3	-	New 2020	£70
3	5820-61-3	Grey	3	-		£70
4	5820-03-3	Black stained ash	3	-		£83
5	5820-05-3	Oak	3	-		£83
6	5820-06-3	Ash	3	-		£83
7	5820-04-3	Walnut	3	-		£88
8	5830-12-3	White	3	58/2/30		£79
9	5830-14-3	Beige	3	-		£79
10	5830-61-3	Grey	3	-		£79
11	5830-03-3	Black stained ash	3	-		£93
12	5830-05-3	Oak	3	-		£93
13	5830-06-3	Ash	3	-		£93
14	5830-04-3	Walnut	3	-		£108
15	7820-12-3	White	3	78/2/20		£79
16	7820-14-3	Beige	3	-	New 2020	£79
17	7820-61-3	Grey	3	-		£79
18	7820-03-3	Black stained ash	3	-		£93
19	7820-05-3	Oak	3	-		£93
20	7820-06-3	Ash	3	-		£93
21	7820-04-3	Walnut	3	-		£108
22	7830-12-3	White	3	78/2/30		£87
23	7830-14-3	Beige	3	-		£87
24	7830-61-3	Grey	3	-		£87
25	7830-03-3	Black stained ash	3	-		£106
26	7830-05-3	Oak	3	-		£106
27	7830-06-3	Ash	3	-		£106
28	7830-04-3	Walnut	3	-		£122

Metal Shelf with Low Edge

Metal shelves with low edge comes in two widths, 58 and 78 cm, and two depths, 20 and 30 cm. For extra functionality combine your metal shelf with hooks, rods, hanger racks and bottle trays.

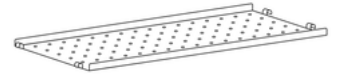

#	Article number	Color	Pack	Width/Height/Depth	Note	Price
1	MSL5820-12-1	White	1	58/2/20		£46
2	MSL5820-14-1	Beige	1	-	New 2020	£46
3	MSL5820-61-1	Grey	1	-		£46
4	MSL5820-13-1	Black	1	-		£46
5	MSL5820-11-1	Galvanized	1	-		£51
6	MSL5830-12-1	White	1	58/2/30		£50
7	MSL5830-14-1	Beige	1	-	New 2020	£50
8	MSL5830-61-1	Grey	1	-		£50
9	MSL5830-13-1	Black	1	-		£50
10	MSL5830-11-1	Galvanized	1	-		£55
11	MSL7820-12-1	White	1	78/2/20		£49
12	MSL7820-14-1	Beige	1	-	New 2020	£49
13	MSL7820-61-1	Grey	1	-		£49
14	MSL7820-13-1	Black	1	-		£49
15	MSL7830-12-1	White	1	78/2/30		£54
16	MSL7830-14-1	Beige	1	-	New 2020	£54
17	MSL7830-61-1	Grey	1	-		£54
18	MSL7830-13-1	Black	1	-		£54

Metal Shelf with High Edge

Metal shelves with high edge comes in two widths, 58 and 78 cm, and two depths, 20 and 30 cm. For extra functionality combine your metal shelf with hooks, rods, hanger racks and bottle trays.

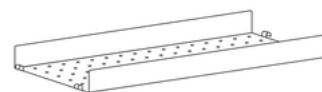

#	Article number	Color	Pack	Width/Height/Depth	Note	Price
1	MSH5820-12-1	White	1	58/7/20		£48
2	MSH5820-14-1	Beige	1	-	New 2020	£48
3	MSH5820-61-1	Grey	1	-		£48
4	MSH5820-13-1	Black	1	-		£48
5	MSH5830-12-1	White	1	58/7/30		£53
6	MSH5830-14-1	Beige	1	-	New 2020	£53
7	MSH5830-61-1	Grey	1	-		£53
8	MSH5830-13-1	Black	1	-		£53
9	MSH5830-11-1	Galvanized	1	-		£58
10	MSH7820-12-1	White	1	78/7/20		£53
11	MSH7820-14-1	Beige	1	-	New 2020	£53
12	MSH7820-61-1	Grey	1	-		£53
13	MSH7820-13-1	Black	1	-		£53
14	MSH7830-12-1	White	1	78/7/30		£55
15	MSH7830-14-1	Beige	1	-	New 2020	£55
16	MSH7830-61-1	Grey	1	-		£55
17	MSH7830-13-1	Black	1	-		£55

Shoe Shelf Metal

The Shoe Metal Shelves are available in white, grey or black finish and in two widths, 58 and 78 cm.

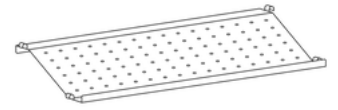

#	Article number	Color	Pack	Width/Height/Depth	Note	Price
1	MSS5830-12-1	<input type="checkbox"/> White	1	58/10/30		£52
2	MSS5830-14-1	<input type="checkbox"/> Beige	1	-	New 2020	£52
3	MSS5830-61-1	<input type="checkbox"/> Grey	1	-		£52
4	MSS5830-13-1	<input type="checkbox"/> Black	1	-		£52
5	MSS7830-12-1	<input type="checkbox"/> White	1	78/10/30		£55
6	MSS7830-14-1	<input type="checkbox"/> Beige	1	-	New 2020	£55
7	MSS7830-61-1	<input type="checkbox"/> Grey	1	-		£55
8	MSS7830-13-1	<input type="checkbox"/> Black	1	-		£55

Work Desk

Work Desk is easy to assemble. Adjust height over time. Work desk can be combined with the Pull Out Drawer.



#	Article number	Color	Pack	Width/Height/Depth	Note	Price
1	7858-12-1	<input type="checkbox"/> White	1	78/2/58		£87
2	7858-14-1	<input type="checkbox"/> Beige	1	-		£87
3	7858-61-1	<input type="checkbox"/> Grey	1	-		£87
4	7858-03-1	<input type="checkbox"/> Black stained ash	1	-		£99
5	7858-05-1	<input type="checkbox"/> Oak	1	-		£99
6	7858-06-1	<input type="checkbox"/> Ash	1	-		£99
7	7858-04-1	<input type="checkbox"/> Walnut	1	-		£112

Magazine shelf wire

Magazine shelves are the perfect place for magazines or perhaps a cook book in the kitchen.

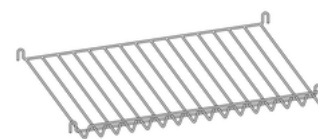

#	Article number	Color	Pack	Width/Height/Depth	Note	Price
1	SM7830-12-1	White	1	78/15/30		£48
2	SM7830-14-1	Beige	1	-		£48
3	SM7830-61-1	Grey	1	-		£48
4	SM7830-13-1	Black	1	-		£48

Magazine shelf wood

Solid magazine shelves are the perfect place for magazines or perhaps a cook book in the kitchen. Magazine shelves are available in two widths, 58 and 78 cm.

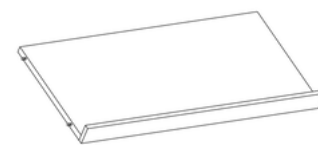

#	Article number	Color	Pack	Width/Height/Depth	Note	Price
1	WM5830-12-1	White	1	58/15/30		£91
2	WM5830-14-1	Beige	1	-		£91
3	WM5830-61-1	Grey	1	-		£91
4	WM5830-03-1	Black stained ash	1	-		£98
5	WM5830-05-1	Oak	1	-		£98
6	WM5830-06-1	Ash	1	-		£98
7	WM5830-04-1	Walnut	1	-		£116
8	WM7830-12-1	White	1	78/15/30		£99
9	WM7830-14-1	Beige	1	-		£99
10	WM7830-61-1	Grey	1	-		£99
11	WM7830-03-1	Black stained ash	1	-		£109
12	WM7830-05-1	Oak	1	-		£109
13	WM7830-06-1	Ash	1	-		£109
14	WM7830-04-1	Walnut	1	-		£127

Bowl shelf

The bowl shelf has three compartments. It is made from ABS plastic and can therefore also be used as a flower pot.

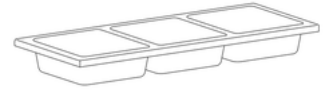

#	Article number	Color	Pack	Width/Height/Depth	Note	Price
1	BS7830-12-1	☐ White	1	78/9/30		£93

Bowl shelf felt

The bowl shelf has three compartments. It is made in felt, reduces the sound level and helps you organize your belongings.

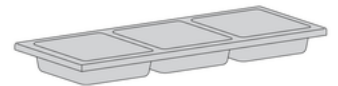







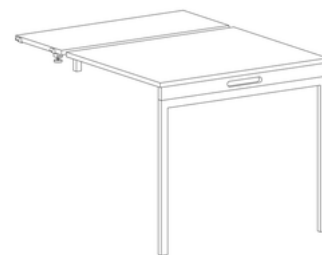

#	Article number	Color	Pack	Width/Height/Depth	Note	Price
1	FBS7830-73-1	■ Beige	1	78/7/30		£122
2	FBS7830-72-1	■ Light grey	1	-		£122
3	FBS7830-71-1	■ Anthracite	1	-		£122

Folding Table

Folding Table is easy to unfold when you need some extra space.
Flexible and easy to assemble.



#	Article number	Color	Pack	Width/Height/Fold up depth/Depth	Note	Price
1	FT7896-12-12	 White/White	1	78/71/96/30 -		£296
2	FT7896-14-14	 Beige/Beige	1	-	New 2020	£296
3	FT7896-61-61	 Grey/Grey	1	-		£296
4	FT7896-03-13	 Black stained ash/Black	1	-		£334
5	FT7896-05-12	 Oak/White	1	-		£334
6	FT7896-06-12	 Ash/White	1	-		£334
7	FT7896-04-12	 Walnut/White	1	-		£353
8	FT7896-04-13	 Walnut/Black	1	-		£353

Cabinet with Mirror Doors

The Cabinet with Mirror Doors can be integrated into String® System in just a few simple steps. The Cabinet with Mirror Doors is available in one width, 78 cm, and one depth, 20 cm.

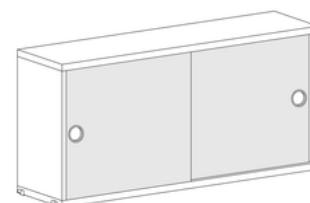

#	Article number	Color	Pack	Width/Height/Depth	Note	Price
1	CM7820-12-1	 White	1	78/37/20		£242
2	CM7820-14-1	 Beige	1	-	New 2020	£242
3	CM7820-61-1	 Grey	1	-		£242

Cabinet with Sliding Doors

The Cabinet with Sliding Doors can be integrated into String® Shelving System in just a few simple steps. The Cabinet is available in one width, 78 cm, and two depths, 20 and 30 cm.

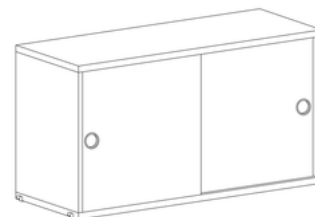

#	Article number	Color	Pack	Width/Height/Depth	Note	Price
1	CD7820-12-1	White	1	78/37/20		£226
2	CD7820-14-1	Beige	1	-	New 2020	£226
3	CD7820-61-1	Grey	1	-		£226
4	CD7820-03-1	Black stained ash	1	-		£274
5	CD7820-05-1	Oak	1	-		£274
6	CD7820-06-1	Ash	1	-		£274
7	CD7820-04-1	Walnut	1	-		£296
8	CD7830-12-1	White	1	78/42/30		£242
9	CD7830-14-1	Beige	1	-		£242
10	CD7830-61-1	Grey	1	-		£242
11	CD7830-03-1	Black stained ash	1	-		£289
12	CD7830-05-1	Oak	1	-		£289
13	CD7830-06-1	Ash	1	-		£289
14	CD7830-04-1	Walnut	1	-		£311

Display Cabinet

The Display Cabinet with Sliding Doors can be integrated into String® Shelving system in just a few simple steps. The Display Cabinet is available in one width, 78 cm, and one depth, 30 cm.

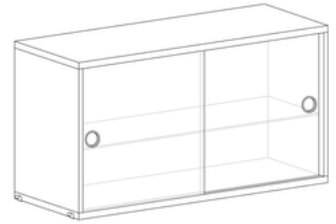

#	Article number	Color	Pack	Width/Height/Depth	Note	Price
1	VS7830-12-1	White	1	78/42/30		£266
2	VS7830-14-1	Beige	1	-		£266
3	VS7830-61-1	Grey	1	-		£266
4	VS7830-03-1	Black stained ash	1	-		£295
5	VS7830-05-1	Oak	1	-		£295
6	VS7830-06-1	Ash	1	-		£295
7	VS7830-04-1	Walnut	1	-		£316

Chest with Drawers

The Chest of Drawers can be integrated into String® Shelving System in just a few simple steps. The Chest comes in two widths, 58 and 78 cm, and one depth, 30 cm.

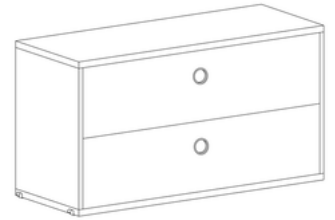

#	Article number	Color	Pack	Width/Height/Depth	Note	Price
1	LH5830-12-1	White	1	58/42/30		£294
2	LH5830-14-1	Beige	1	-		£294
3	LH5830-61-1	Grey	1	-		£294
4	LH5830-03-1	Black stained ash	1	-		£321
5	LH5830-05-1	Oak	1	-		£321
6	LH5830-06-1	Ash	1	-		£321
7	LH5830-04-1	Walnut	1	-		£346
8	LH7830-12-1	White	1	78/42/30		£307
9	LH7830-14-1	Beige	1	-		£307
10	LH7830-61-1	Grey	1	-		£307
11	LH7830-03-1	Black stained ash	1	-		£341
12	LH7830-05-1	Oak	1	-		£341
13	LH7830-06-1	Ash	1	-		£341
14	LH7830-04-1	Walnut	1	-		£367

Filing cabinet

Filing cabinet is an efficient storage with two adjustable shelves. Easily integrated into String® System and Works™ ..by String Furniture. The Filing cabinet is available in one width, 78 cm, and one depth, 30 cm.



#	Article number	Color	Pack	Width/Height/Depth	Note	Price
1	FC7832-12-1	White	1	78/77/30		£390
2	FC7832-05-1	Oak	1	-		£456
3	FC7832-06-1	Ash	1	-		£456

Knife holder

The newly added accessory, Knife holder, keeps your knives in good shape and in place. It is very handy to hang on the side panel of your String® combination.

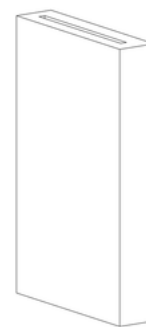













#	Article number	Color	Pack	Width/Weight/Height/Depth	Note	Price
1	SKH-55-1	 Oak	1	31/1.5/19/4	New 2020	£84

Rods for metal shelves

The Rods are part of String® Systems range of accessories. All accessories are design with the mindset of increasing functionality by enabling for more and creative storage possibilities



#	Article number	Color	Pack	Width/Height/Depth	Note	Price
1	MSR30-12-1	 White	1	30/8/1		£31
2	MSR30-14-1	 Beige	1	-	New 2020	£31
3	MSR30-61-1	 Grey	1	-		£31
4	MSR30-13-1	 Black	1	-		£31
5	MSR58-12-1	 White	1	58/8/1		£35
6	MSR58-14-1	 Beige	1	-	New 2020	£35
7	MSR58-61-1	 Grey	1	-		£35
8	MSR58-13-1	 Black	1	-		£35
9	MSR78-12-1	 White	1	78/8/1		£37
10	MSR78-14-1	 Beige	1	-	New 2020	£37
11	MSR78-61-1	 Grey	1	-		£37
12	MSR78-13-1	 Black	1	-		£37

Hanger rack

The Hanger racks are part of String® Systems range of accessories. All accessories are design with the mindset of increasing functionality by enabling for more and creative storage possibilities. The hanger racks come in two depths, 20 and 30 cm.



#	Article number	Color	Pack	Width/Height/Depth	Note	Price
1	SHR20-12-2	White	2	14/3/20		£40
2	SHR20-14-2	Beige	2	-	New 2020	£40
3	SHR20-61-2	Grey	2	-		£40
4	SHR20-13-2	Black	2	-		£40
5	SHR30-12-2	White	2	14/3/30		£43
6	SHR30-14-2	Beige	2	-	New 2020	£43
7	SHR30-61-2	Grey	2	-		£43
8	SHR30-13-2	Black	2	-		£43

Bottle tray

The Bottle tray is part of String® Systems range of accessories. All accessories are design with the mindset of increasing functionality by enabling for more and creative storage possibilities.



#	Article number	Color	Pack	Width/Height/Depth	Note	Price
1	SBT-12-2	White	2	18/3/23		£28
2	SBT-61-2	Grey	2	-		£28
3	SBT-13-2	Black	2	-		£28

Coat hanger

The Coat-hangers are part of String® Systems range of accessories. All accessories are design with the mindset of increasing functionality by enabling for more and creative storage possibilities



#	Article number	Color	Pack	Width/	Note	Price
1	SCH-12-4	White	4	40/26 -		£25
2	SCH-14-4	Beige	4	-	New 2020	£25
3	SCH-61-4	Grey	4	-		£25
4	SCH-13-4	Black	4	-		£25

Hooks for metal shelves

The J hooks are part of String® Systems range of accessories. All accessories are design with the mindset of increasing functionality by enabling for more and creative storage possibilities.



#	Article number	Color	Pack	Width/Height/Depth	Note	Price
1	MSK-12-5	White	5	0.5/8.5/3.5		£19
2	MSK-14-5	Beige	5	-	New 2020	£19
3	MSK-61-5	Grey	5	-		£19
4	MSK-13-5	Black	5	-		£19
5	MSK-10-5	Stainless steel	5	-	New 2020	£21

S hook

The S hooks are part of String® Systems range of accessories. All accessories are design with the mindset of increasing functionality by enabling for more and creative storage possibilities.

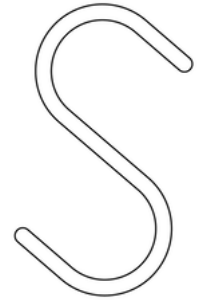

#	Article number	Color	Pack	Width/Height/Depth	Note	Price
1	MKS-10-5	■ Stainless steel	5	5/1/5		£14

Organizers

The Organizers are part of String® Systems range of accessories. All accessories are design with the mindset of increasing functionality by enabling for more and creative storage. The organizers come in a set with 3 different sizes: w9xd7xh12, w20xd8xh8 and w12xd8xh12.

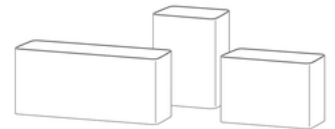

#	Article number	Color	Pack	Width/Height/Depth	Note	Price
1	ORGMIX-12-3	□ White	1	9/12/7 - 20/8/8 - 12/12/8		£32
2	ORGMIX-61-3	■ Grey	1	-		£32
3	ORGMIX-13-3	■ Black	1	-		£32

Magazine holder

The Magazine holder is part of String® Systems range of accessories. All accessories are design with the mindset of increasing functionality by enabling for more and creative storage possibilities.

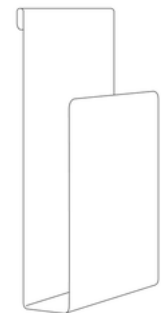

#	Article number	Color	Pack	Width/Height/Depth	Note	Price
1	SMH-12-1	□ White	1	5/27/17		£32
2	SMH-61-1	■ Grey	1	-		£32
3	SMH-13-1	■ Black	1	-		£32

Pull Out Drawer

Pull out drawer for height-adjustable work desk and the work desk
78x58 cm.

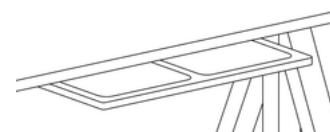

#	Article number	Color	Pack	Width/Depth	Note	Price
1	PD5830-12-1	<input type="checkbox"/> White	1	58/30		£70

Museum

Museum shelf

The Museum shelf is a functional and versatile shelf that can be used to display a treasured artwork or as a bedside table.



#	Article number	Color	Pack	Width/Height/Depth	Note	Price
1	NM045-18-12	<input type="checkbox"/> White	1	28/8/24		£121
2	NM045-18-14	<input type="checkbox"/> Beige	1	-		£121
3	NM045-18-19	<input type="checkbox"/> Aluminum	1	-		£121

Works

Height adjustable table frame

Flexible and ergonomic work environment. Electrical height-adjustable table frame for work desk and conference table

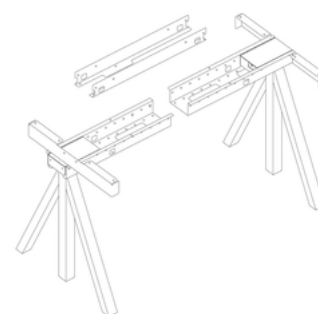

#	Article number	Color	Pack	Note	Price
1	ETF-12-1	<input type="checkbox"/> White	1		£882

Table Frame extension

Table frame extension combined with the table frame, makes it possible to create a height-adjustable conference table.

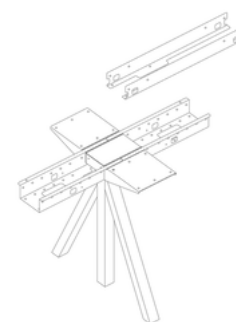

#	Article number	Color	Pack	Note	Price
1	ETE-12-1	<input type="checkbox"/> White	1		£487

Desktop

Desktop for height adjustable table frame. Available in four widths, 120, 140, 160 och 180 cm.



#	Article number	Color	Pack	Width/Depth	Note	Price
1	DT12078-22-1	White laminate	1	120/78		£230
2	DT12078-05-1	Oak	1	-		£230
3	DT12078-06-1	Ash	1	-		£230
4	DT12078-24-1	Light grey linoleum	1	-	New 2020	£325
5	DT14078-22-1	White laminate	1	140/78		£262
6	DT14078-05-1	Oak	1	-		£262
7	DT14078-06-1	Ash	1	-		£262
8	DT14078-24-1	Light grey linoleum	1	-	New 2020	£368
9	DT16078-22-1	White laminate	1	160/78		£300
10	DT16078-05-1	Oak	1	-		£300
11	DT16078-06-1	Ash	1	-		£300
12	DT16078-24-1	Light grey linoleum	1	-	New 2020	£430

Conference Table Top

Desktop for height adjustable conference table.



#	Article number	Color	Pack	Width/Depth	Note	Price
1	DT18090-22-1	White laminate	1	180/90		£387
2	DT18090-05-1	Oak	1	-		£387
3	DT18090-06-1	Ash	1	-		£387
4	DT18090-24-1	Light grey linoleum	1	-	New 2020	£538

Wire screen for desktop

The wire screen can be used as a semi-transparent partition between workstations and as a bulletin board or holder for organizers.

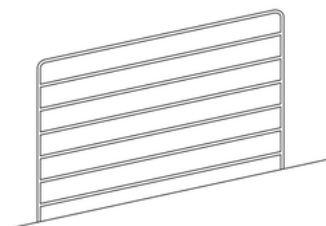

#	Article number	Color	Pack	Width/Height	Note	Price
1	DWS-12-1	<input type="checkbox"/> White	1	58/32		£50

Fabric sleeve for wire screen

The fabric sleeve fits wire screen for desktop and create more privacy at your work space and also reduces the sound level.

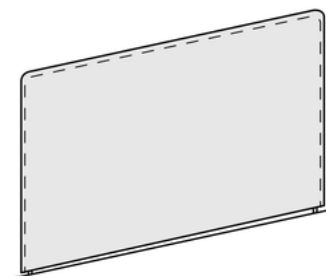

#	Article number	Color	Pack	Width/Height	Note	Price
1	FWS-61-1	<input checked="" type="checkbox"/> Grey	1	60/36		£48

Computer Holder

The PC holder keeps your computer in place and off the floor.

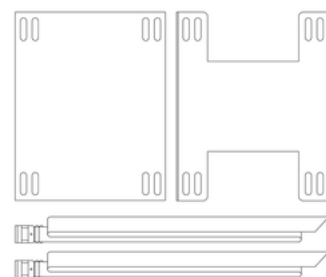

#	Article number	Color	Pack	Note	Price
1	PCH-12-1	<input type="checkbox"/> White	1		£53

Mobile storage unit

Mobile storage unit with two drawers. It can easily be moved by use of an inset wire handle on the back.

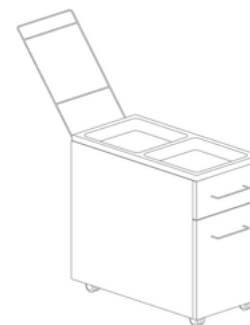

#	Article number	Color	Pack	Width/Height/Depth	Note	Price
1	DC3058-12-1	White	1	30/51/58		£369
2	DC3058-05-1	Oak	1	-		£422
3	DC3058-06-1	Ash	1	-		£422

Freestanding

The free-standing shelf with partition in felt to reduce noise. Easily integrated into String® System and Works ..by String Furniture.

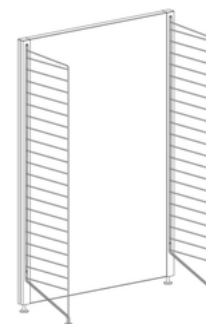

#	Article number	Color	Pack	Width/Height/Depth	Note	Price
1	FF-12-61-1	Grey	1	74/118/4		£187
2	UF118-12-1	White	1	118		£86

Bowl for freestanding

A round bowl, as an accessory to the freestanding shelf.

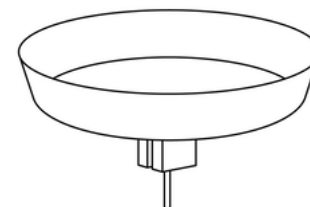

#	Article number	Color	Pack	Width/Height/Depth	Note	Price
1	BF28-12-1	White	1	28/10/28		£79